

# Adjustable Base QF04K2W Wireless



## Owner's Manual

**INNOVA**  
SLEEP SYSTEMS

### CONTENTS

#### Advisory

#### Setup and Installation

#### Wireless Hand Control

#### 1-3-20 year Warranty

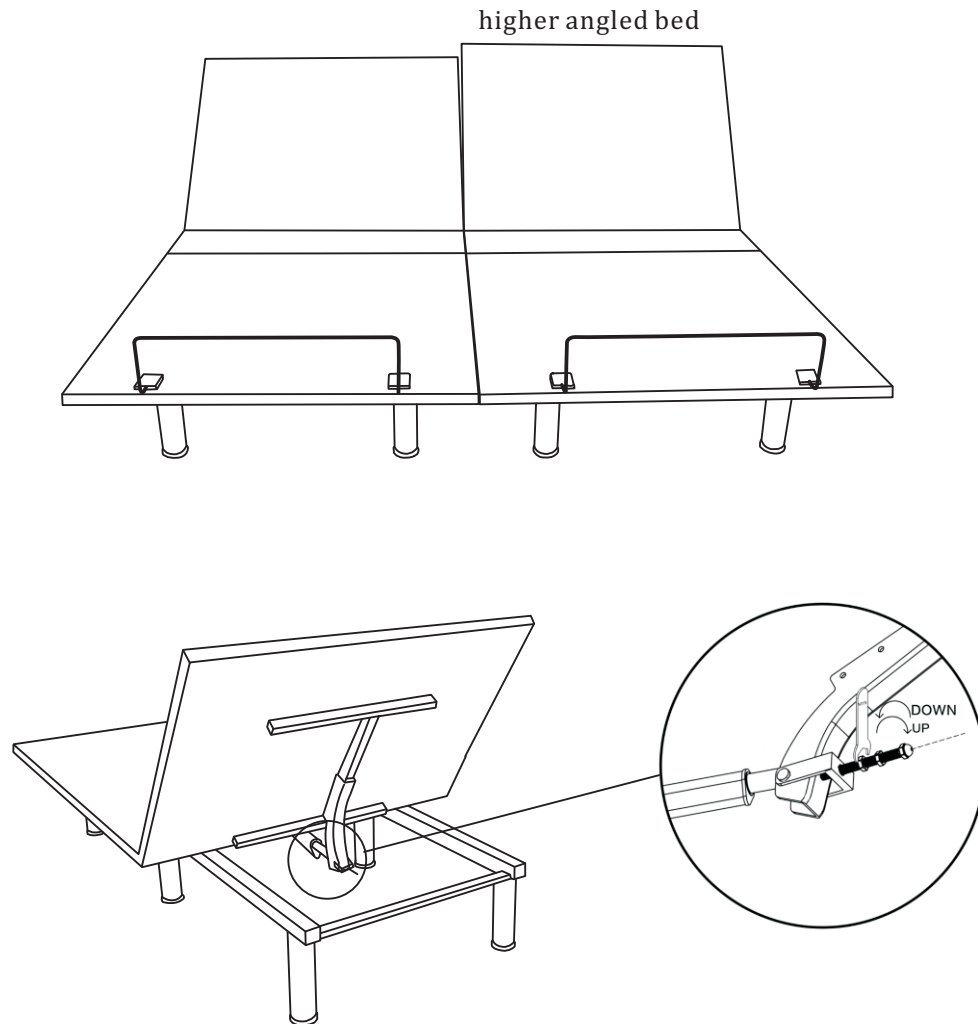

#### WHEN TWO BEDS DO NOT ALIGN:

on the higher angled bed of the two, use a 19mm wrench to turn the nuts on the new "LEVEL RIGHT" counterclockwise to adjust the angle until the higher angle bed match the level of the lower angle bed and lock the nut with the reinforce nuts.

The two beds are now aligned. **(for Twin XL and Split CK)**

## WARNING

**Attention: Read the following information before using this product. Failure to use a surge protection device could compromise safety or cause product malfunction and could void the electrical portion of your warranty.**

Electrical surges are by far the biggest cause of problems with electrical circuits. In order to help protect your investment in case of a power surge or outage, use an electrical surge protection device (not included).

### WARRANTY WARNING!

Do not open or tamper with the transformer, control box, motors, or remote control (with the exception of battery compartments). The product warranty will be void if these components are tampered with.

### SMALL CHILDREN AND PETS:

Immediately dispose of all packing materials as they can smother small children and pets. Do not allow any persons or pets under the bed. Children, convalescents and disabled person should not operate the bed without adult supervision.

### HOSPITAL OR CONVALESCENT USE DISCLAIMER:

Adjustable beds are designed and engineered for a life style of in-home comfort and are not intended for hospital use or for a bed-ridden patient on an extended recovery. Adjustable beds are not equipped with bars to help patients get safely in and out of bed and are not intended to be used around tent type oxygen therapy or explosive gases.

receive all service and transportation cost for verification. In years 4-5 years, purchaser shall pay all service and transportation costs related to the replacement of the defective part and required to pay 1/10 of the current replacement cost of the parts times the number of years used. In years 6-20 years, purchaser shall pay all service and transportation costs related to the replacement of the defective part and required to pay 60% of the replacement parts cost and pay 2% of the current replacement cost of the parts times the number of years used.

### ADDITIONAL TERMS AND CONDITIONS

This warranty does not apply: (a) to any damage caused by the purchaser; (b) if there has been any repair or replacement of adjustable bed parts by an unauthorized person; (c) if the adjustable bed has been mishandled (whether in transit or by other means), viz, subjected to physical or electrical abuse or misuse, or otherwise operated in any manner inconsistent with the operation and maintenance procedures outlined in the Owner's Manual and this warranty; (d) to damage to mattresses, fabric, cables, electrical cords or items supplied by dealers. (Contact the dealers for warranty information on those items;) (e) if there has been any modification of the adjustable bed without prior written consent by Innova; (f) to costs for unnecessary service calls, including costs for in-home service calls solely for the purpose of education the consumer about the adjustable bed or finding an unsatisfactory power connection; (g) if the recommended weight restriction is not followed (refer to the advisory section of this manual), the warranty will be void; (h) to the use of the adjustable bed base in whatsoever and howsoever manner other than the personal in home use exclusively by the purchaser. Repairs to or replacement of an adjustable bed base or its components under the terms of this limited warranty will apply to the original warranty period and will not serve to extend such period. The decision to repair or to replace defective parts under this warranty shall be made, or cause to be made, by Innova at its option and in its sole discretion. Repair or replacement shall be the sole remedy available to the purchaser. There shall be no liability on the part of Innova for any special, indirect, incidental, or consequential damages or to any other damage, claim, or loss not expressly covered by the terms of this warranty. This limited warranty does not include reimbursement for inconvenience, removal, installation, setup time, loss of use, shipping, or any other costs of expenses, Innova and/or its service technicians shall not be responsible for moving furniture or any other items not originally attached to the adjustable bed in order to perform service on the adjustable bed. It is the sole responsibility of the purchaser to provide adequate space and accessibility to the adjustable bed. In the event that the technician is unable to perform service due to lack of accessibility, the service call will be billed to the purchaser and the service will have to be rescheduled. Innova makes no other warranty whether expressed or implied, and all implied warranties of merchantability and fitness for a particular purpose are disclaimed by Innova and excluded from this warranty. Some states do not allow the exclusion or limitation of incidental or consequential damages, so the above limitation or exclusion may not apply to every purchaser. This warranty gives the purchaser specific legal rights, and the purchaser may also have other rights, which may vary from state to state. This warranty is valid in all 50 states, Puerto Rico, and Canada.

## INNOVA SLEEP PRODUCT

### 1, 3 & 20 YEAR LIMITED WARRANTY

Innova Sleep Products, Inc. (“Innova”) warrants this adjustable bed to the consumer who is the original purchaser of a new product which was not sold “as is” (the “purchaser”), subject to the terms and conditions set forth herein. This warranty begins on the “warranty commencement date” which is the date of purchase for new unused beds base. But not more than 3 years from the date of manufacture.

Part Name	Parts warranty period	Labor warranty period
Motor(s)	3 years	first year
Transformer(s)	3 years	first year
Control box(es)	3 years	first year
Remote control	1 year	
USB	1 year	

During the Parts warranty period, there will be no charge for parts. During the Labor warranty period, there will be no charge for labor. If repair is needed during the warranty period, the purchaser will be required to produce a sales receipt/proof of purchase evidencing the date of purchase, the amount paid and the place of purchase. If no such sales receipt/proof of purchase is produced, full amount of charges for labor and the parts shall be paid before any services could be rendered.

#### FULL first YEAR WARRANTY

This adjustable bed is warranted against defects in the workmanship or materials for a period of first year from the warranty commencement date. Upon notice during the first year after the warranty commencement date, Innova will repair or replace (at no cost to the purchaser) any defective adjustable bed base part with new or refurbished parts, and Innova will pay all authorized labor and transportation costs associated with the repair or replacement of any parts found to be defective. When the adjustable bed at hand is found to be DAMAGE, not DEFECT, all costs incurred to inspect and/or correct the requested issue will be the financial responsibility of the requesting party.

#### 3 YEAR LIMITED WARRANTY

During the second year from the warranty commencement date, upon receipt of notice, Innova will replace any adjustable bed base part found to be defective with new or refurbished parts. Purchaser shall pay all service and transportation costs related to the replacement of the defective part. This limited three (3) year warranty shall not apply unless the defective part is returned to Innova and Innova receive all service and transportation cost for verification.

#### 20 YEAR LIMITED WARRANTY

Upon written notice during the forth year through the 20th year from the warranty commencement date, Innova will replace, upon terms and conditions set forth in this paragraph, any mechanical bed base parts found to be defective. Electronics, electrical components, drive motors and massage motors are also excluded. This limited lifetime warranty shall not apply unless the defective part is returned to Innova and Innova

### PRODUCT RATINGS:

The bed lift motors are not designed for continuous use of more than 2 minutes in an 18 minutes period, or approximately 10% duty cycle. **Any attempt to circumvent or exceed this rating will shorten the life expectancy of the product and may void the warranty.**

### WEIGHT UNITS:

The limitation for this adjustable bed is 850 lbs. The bed will structurally support these weights, provided it is evenly distributed across the head and foot sections. This product is not designed to support or lift this amount in the head or foot section alone. **Exceeding this weight restriction could damage the bed and/or cause injury and void the warranty.** Enter or exit the bed in a flat position and do not sit on the head or foot sections while in the raised position.

### LIFTING AND LOWERING MECHANISMS :

It is normal for the raising and lowering feature on this bed to emit a minimal humming sound during operation.

### LOCATION ENVIRONMENT:

The level of sound experienced in a room is directly related to the environment within that location. In a room with hardwood floors and the massagers turned on, a vibrating noise can be noticeable. To reduce the resonance, place a piece of carpet or rubber casters cups under the legs. The rubber caster cups also prevent the bed sliding when located on smooth or hard surface flooring.

### TO REDUCE THE RISK OF SHOCK, BURNS, FIRE OR INJURY:

Make sure the base is in a flat position. Always unplug the base from the electrical outlet before cleaning or servicing the base. If the cord or plug is damaged, discontinue use of the bed base and contact qualified service personnel for examination and repair.

#### FCC COMPLIANCE:

This device complies with part 15 of the FCC Rules for residential use. Operation is subject to the following two conditions: (1) This device may not cause harmful interference, and (2) this device must accept any interference received, including interference that may cause undesired operation.

Radio Frequency: 2.4 GHz

#### EMERGENCY BATTERY BACKUP:

In the event that the base is stuck in an articulated position during a power outage-the battery backup in the transformer will return the base to flat position. Batteries are not to be used for normal operation of the base. Install two 9 volt alkaline batteries into the battery backing transformer. Use the reset button on the control box or the extension cord from the control box to the transformer to return the base to a flat position.

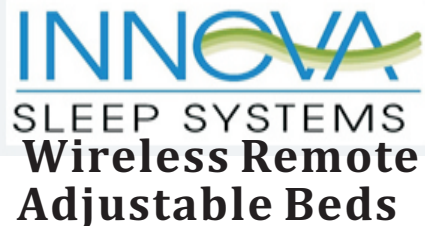
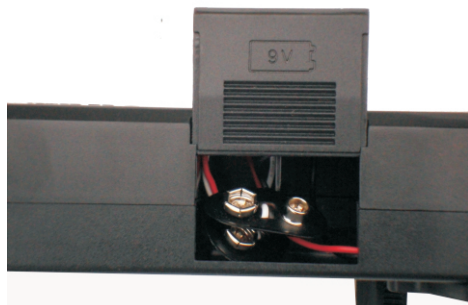

## Wireless Remote Adjustable Beds

#### Preset Position Button M.

1. Adjust the head and foot to desired positions.
2. Press and continue holding in the "ZG" button for around 5 seconds until the Indicator light on remote control flashes, confirm the successful setting.
3. You can reset the ZG position button by repeating the above steps.

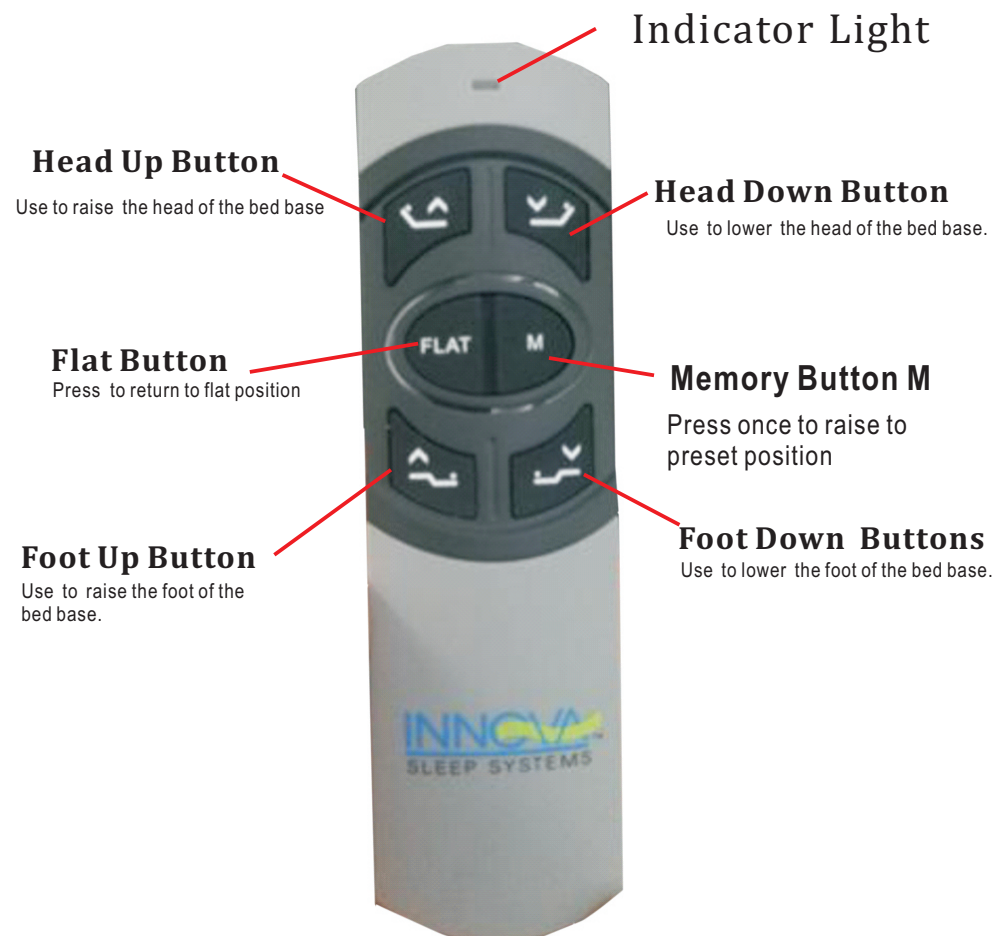

For toll-free customer service, call 1-877-386-1373 (US)

or email us: [service@innovasleep.com](mailto:service@innovasleep.com)

Please tell us your name, phone, address, Model Name and/or Model ID (found on the law label tags, which are stapled to the head of the base), purchase date, and the question or concern when you call/email.



## USING SAME REMOTE:

The bed base is designed to allow two twin X-Long bases to become an Eastern King base and two Split-Cal-King bases to become a Cal-King base. Owner can use the same remote to control two side by side beds bases by Connecting the two control boxes with the sync cable pictured below. To do this, plug one side of the cable into the “SYNC” port on the side of the control box and plug another side into the “SYNC” port on the side of another control box , then you can connect two control boxes (See figure 8&9). Next, pair your remote to one of the control boxes by following the sync instructions on page 6.



Figure 8

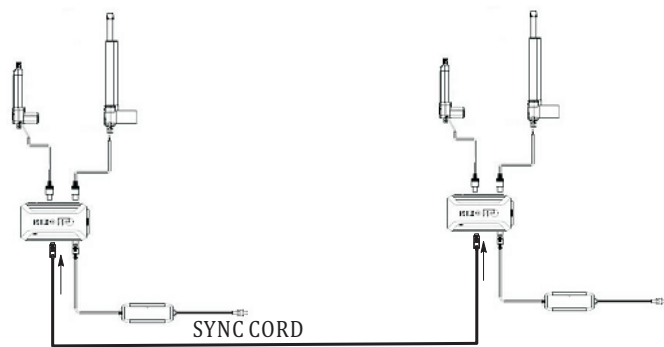

Figure 9

The synchronise cord is not on the full warranty list. We will replace the it for free if the defective one is mailed back.

Setup is now complete. Enjoy.

## SETUP and INSTALLATION

### Important: We strongly recommend two able-bodied adults setup and assemble this product.

#### Step 1:

Check and verify all parts are included before discarding any packing materials.

All electronics and components that need to be installed are located in boxes under the base or attached to the frame.

- A) Wireless Remote Control (1)
- B) Mattress Retainer Bar (1)
- C) Power Cord AC (1)
- D) Power Cord DC (1)
- E) Transformer with emergency battery backup (1)
- F) Control Box (1)
- G) SYNC CORD (1) (for TWIN XL and SPLIT CK)
- H) Legs 4" x 7" (6)

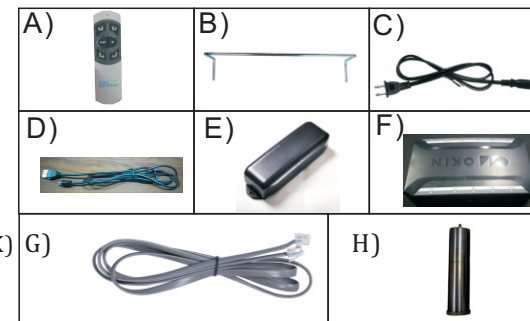

#### Step 2:

With the help of your able-bodied assistant, place carton on floor with arrows point downwards.

#### Step 3:

Connect the Transformer “F” to Control Box “G” : The Control Box is the Black Box attached to the bottom of the bed . Plug one side of power cord DC “E” into the Control Box “G” and plug another side of power cord DC “E” into Transformer “F” . the Power Cord AC “D” plug into Transformer “F” . (See Figure 2)

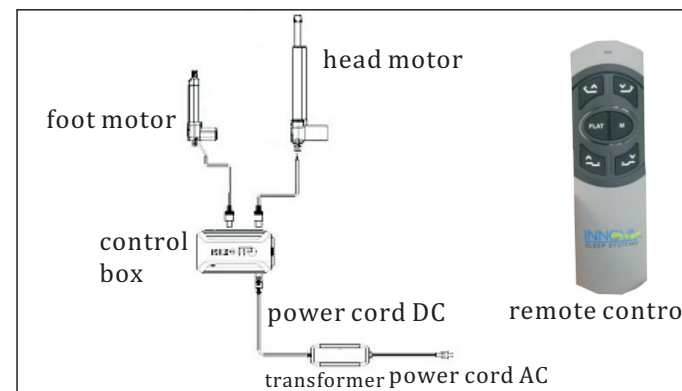

Figure 2

Step 4:  
Locate the Wireless Remote control and insert 2 AAA batteries (See Figure 4) .

Step 5& 6:  
Plug electrical cord into a grounded electrical outlet.  
Push the Head Up button, Foot Up button and Flat Button for a momentary test of the Wireless Remote. Please note that the actuator is a gravity down motor , it needs weight to come down . If the motor is working quickly let go of the button and skip to step 8.

Step 7:  
Synchronize the remote with the control box. First find the black box mounted under the bed. Double - click the black PAIR buttons, the Indicator Light of the control box change to blue , then press HEAD UP and HEAD DOWN buttons simultaneously until the Indicator Light on remote control is flashing ,the Indicator Light of the control box changes from blue to green and constant. The adjustable bed should be working after matching the remote with the control box . Press the Head Up button , Foot Up button , and Flat Button to test .



Figure 4

Figure 5 PAIR button

Step 8:  
Unplug the Power Cord.  
Install the six legs firmly into the base of the frame. The legs screw into the threaded holes around the perimeter of the adjustable base frame (See Figure 6). The legs are stackable and are 4” and 7”. The combination gives you a set of six 4”, 7”, or 11” legs. The minimum height for this base is 4”.

**Do not over tighten.**



Figure 6

Step 9:  
With the help of your able-bodied assistant , carefully lift the adjustable bed frame and set it in place upright on its legs . Excessive pressure may damage the legs. Remove all protective plastic covering. Note: check and make sure that all power cords clear and do not interfere with any Adjustable Bed Mechanisms; Dispose of covering properly to avoid injury.

Step 10:  
Note: The Mattress Retaining Bar is tied to the underside of the base for shipping. Install the Mattress Retaining Bar upright by carefully aligning and pushing the bar into place. Insert the Mattress Retaining Bar into the holders at the foot of the bed. (Figure 7)

The Mattress Retaining Bar prevents the mattress from slipping off the base and should not be used as a handle of the base. Using as a handle will damage the retaining bar holders. Screws come out from the retainer bar holders will be considered as a damaged part and not a defective part and is not covered by the warranty.



Figure 7