

INNOVA

SLEEP SYSTEMS

OWNER'S MANUAL

PIONEER II

Model SFNA02M1W



Table of Contents

Precautions	3
Parts List	5
Installation Guide	6
Remote Control Instructions	10
Warranty Info.....	13

PRECAUTIONS

WARNING

Read the following information before using this product. Failure to adhere to these terms and precautions could compromise safety, cause product malfunction and/or void a portion of your warranty.

Electrical power surges are a leading cause of problems with electrical circuits. In order to help protect your investment in case of a power surge or outage, use an electrical surge protection device (not included).

WARRANTY WARNING!

Do not open or tamper with the transformer, control box, motors, or remote control (with the exception of opening battery compartments as necessary). Your product warranty will be void if these components are tampered with.

Do not remove the law label attached to the base of this product. Removing the law label may delay the processing, or void all or a portion, of your warranty claim.

SMALL CHILDREN AND PETS:

Immediately dispose of all packing materials as they can smother, choke, or otherwise harm small children and pets. Do not allow any person or pets under the bed. Children, convalescents, and disabled persons should not operate the bed without adult supervision.

HOSPITAL OR CONVALESCENT USE DISCLAIMER:

This adjustable base is designed and engineered for a lifestyle of in-home comfort and not intended for hospital use, for a bed-ridden persons, or for an extended recovery. This product is not equipped with bars to help persons get safely in and out of bed and is not intended for use around tent type oxygen therapy or explosive gases.

PRODUCT RATINGS:

The product's lift motors are not designed for continuous use of more than 2 minutes in an 18 minute period, or approximately 10% duty cycle. Any attempt to circumvent or exceed this rating will shorten the life expectancy of the product and may void the warranty.

WEIGHT LIMITS:

The limitation for this product is 750 lbs. This product will structurally support up to 750 lbs, provided the mattress is evenly distributed across the product and the weight isn't concentrated in one area. This product is not designed to support or lift such amounts in the head or foot section alone. Exceeding this weight restriction will void the warranty and could damage the bed and/or cause injury. Enter and exit the bed in a flat position and do not sit on the head or foot sections while this product is in the raised position.

ELECTRONIC MECHANISMS:

It is normal for the raising and lowering feature of this product to emit a minimal humming sound during operation. The massage feature creates a vibrating hum during operation and the resonance will increase accordingly with a higher intensity motor setting.

LOCATION ENVIRONMENT:

The level of sound experienced in a room is directly related to the environment within that location. In a room with hardwood floors and the massager turned on, a vibrating noise may be noticeable. Placing a piece of carpet or rubber casters cups under the legs of the product may reduce this resonance. The rubber caster cups also prevent the product from sliding when located on smooth or hard surface flooring.

TO REDUCE THE RISK OF SHOCK, BURNS, FIRE OR INJURY:

Make sure the product is in the flat position before unplugging from power source. Always unplug the product from the electrical outlet before cleaning or servicing the product. If the cord or plug is damaged, document the damage and contact customer service for advisement on continued use.

MINIMUM LEG HEIGHT:

The minimum leg height is 4". Using this product without legs or with legs shorter than 4" will void the warranty.

FCC COMPLIANCE:







This device complies with part 15 of the FCC Rules for residential use. Operation is subject to the following two conditions: (1) This device may not cause harmful interference, and (2) this device must accept any interference received, including interference that may cause undesired operation.

Radio Frequency: 2.4 GHz

PARTS LIST

Step 1:

Check and verify all parts are included before discarding any packing materials. All electronics and components that need to be installed are located in boxes under the base or attached to the frame (* indicating that the parts attached to the base).

 <p>A) Wireless Remote Control (1)</p>	 <p>B) Mattress Retainer Bar (1), Mattress Retainer Bar (2) for King size bases</p>	 <p>C) Legs (6), and Legs (7) for Kings size bases</p>
 <p>D) Power Cord (1)</p>	 <p>E) Transformer (1)</p>	 <p>F) Control Box *(1)</p>

Important: We strongly recommend two able-bodied adults setup and assemble this product.

SET UP & INSTALLATION

Step 2:

With two able-bodied people, place carton on floor and remove the lid on the box.



Step 3:

It is recommended to test the bed while still in the box before fully setting up.

- Connect the Transformer “E” to the motor. Extend the cord from the motor and attach to the short electrical output cord on Transformer “E”.
- Extend the Power Cord “D” and plug it into the Transformer “E”. (See Figure 1)

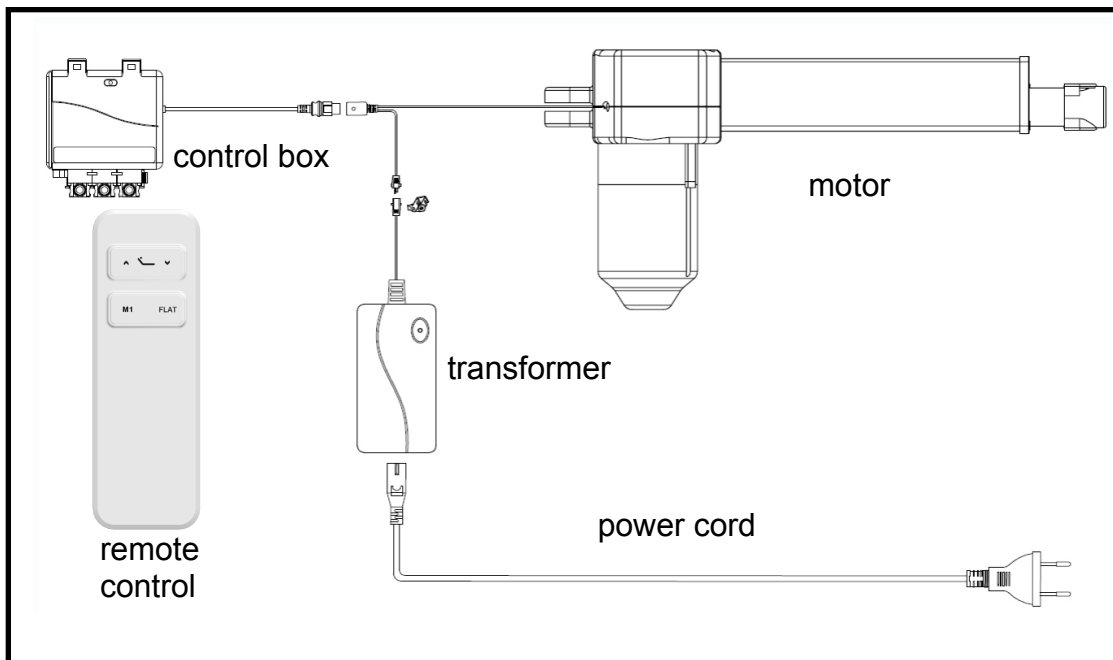

Figure 1

Step 4:

Insert 3 AAA batteries into the Wireless Remote.

Step 5:

Plug the Power Cord into a grounded electrical outlet. A surge protector is recommended.

Using the Wireless Remote Control, push the HEAD UP button and then push the HEAD DOWN button to test the bed. If the motors are working, skip to step 7.

NOTE: The actuator is a gravity down motor, which needs weight to be lowered.

Step 6:

Synchronize the Wireless Remote with the Control Box:

After plugging in the base to a grounded outlet, the base will return to flat position and you will hear a beep. At this time, it enters the syncing state for ten seconds. (If you have not completed syncing within ten seconds, repeat the above step.)

Then press HEAD UP and HEAD DOWN buttons simultaneously for 3-5 seconds while the control box lights are still flashing. (See Figure 2) You will hear another beep and remote lights will flash blue when syncing is successful.

The adjustable bed should work after syncing the Wireless Remote with the Control Box. Press the HEAD UP button and then HEAD DOWN buttons to test.

If syncing is not successful or you need to sync again, repeat the above steps.



Figure 2

Refer to page 12 for instructions for syncing two remotes to the same base or using one remote for two bases.

WE STRONGLY RECOMMEND:

In order to help protect your investment in case of a power surge or outage, use an electrical surge protection device with a battery backup system (not included) and plug it in to a grounded outlet.

Step 7:

Unplug the Power Cord.

Install the six legs (or seven legs for King size bases) firmly into the base of the frame. The legs screw into the threaded holes around the perimeter of the adjustable base frame (see Figure 3).

The legs are 13". There are six 13" legs (or seven 13" legs for King size bases). The minimum leg height is 4".

Do not over tighten.

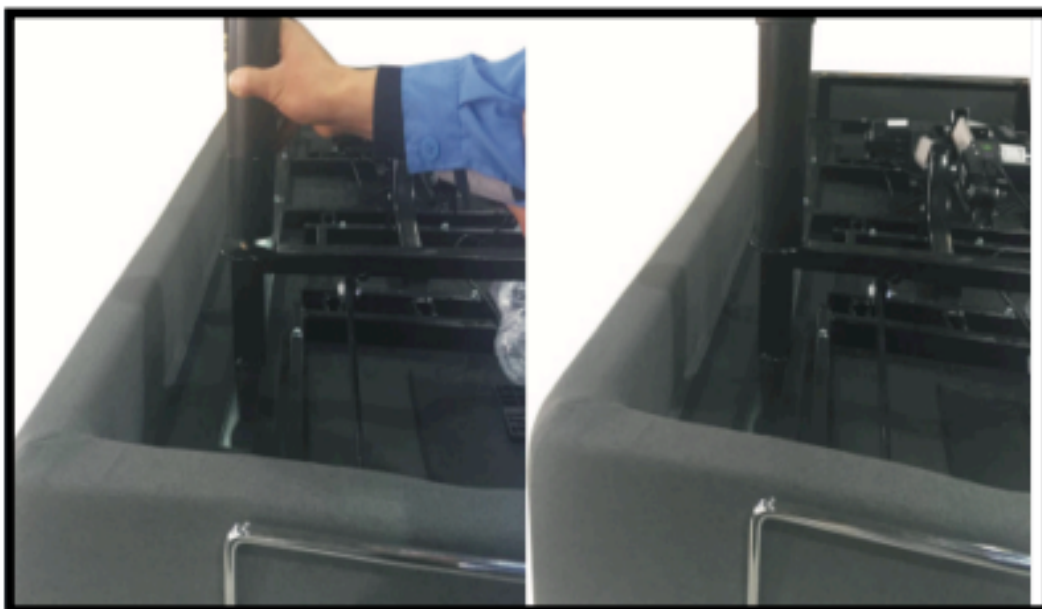

Figure 3

Step 8:

With the help of your able-bodied assistant, carefully lift the adjustable bed frame and set it in place upright on its legs. Excessive pressure and dragging the bed without lifting may damage the legs. Remove all protective plastic covering.

Note: Check and make sure that all power cords are untangled and do not interfere with any adjustable bed mechanisms.

Dispose of covering properly to avoid injury.

Step 9:

Note: The Mattress Retaining Bar is tied to the underside of the base for shipping. Install the Mattress Retaining Bar upright by carefully aligning and pushing the bar into place.

Insert the Mattress Retaining Bar into the holders at the foot of the bed. (Figure 4)

The Mattress Retaining Bar prevents the mattress from slipping off the base and should not be used as a handle of the base. Using as a handle will damage the retaining bar holders. Screws come out from the retainer bar holders will be considered as a damaged part and not a defective part and is not covered by the warranty.

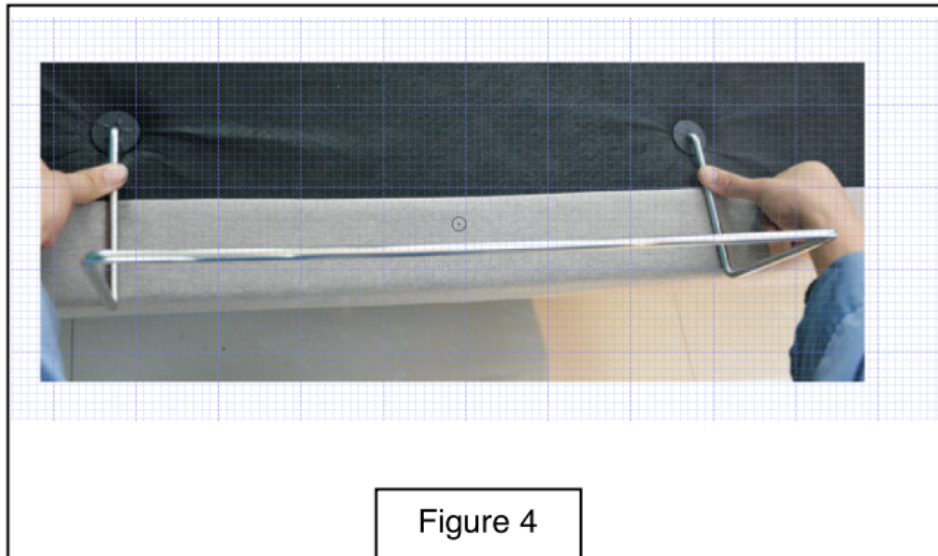

Setup is now complete.

Plug your base back in and enjoy your new adjustable bed.

Wireless Remote Control Instructions

**For toll-free customer service, call 1-877-386-1373 (US)
or email us: service@innovasleep.com**

Please tell us your name, phone, address, Model Name and/or Model ID (found on the law label tags, which are stapled to the head of the base), purchase date, and the question or concern when you call/email.

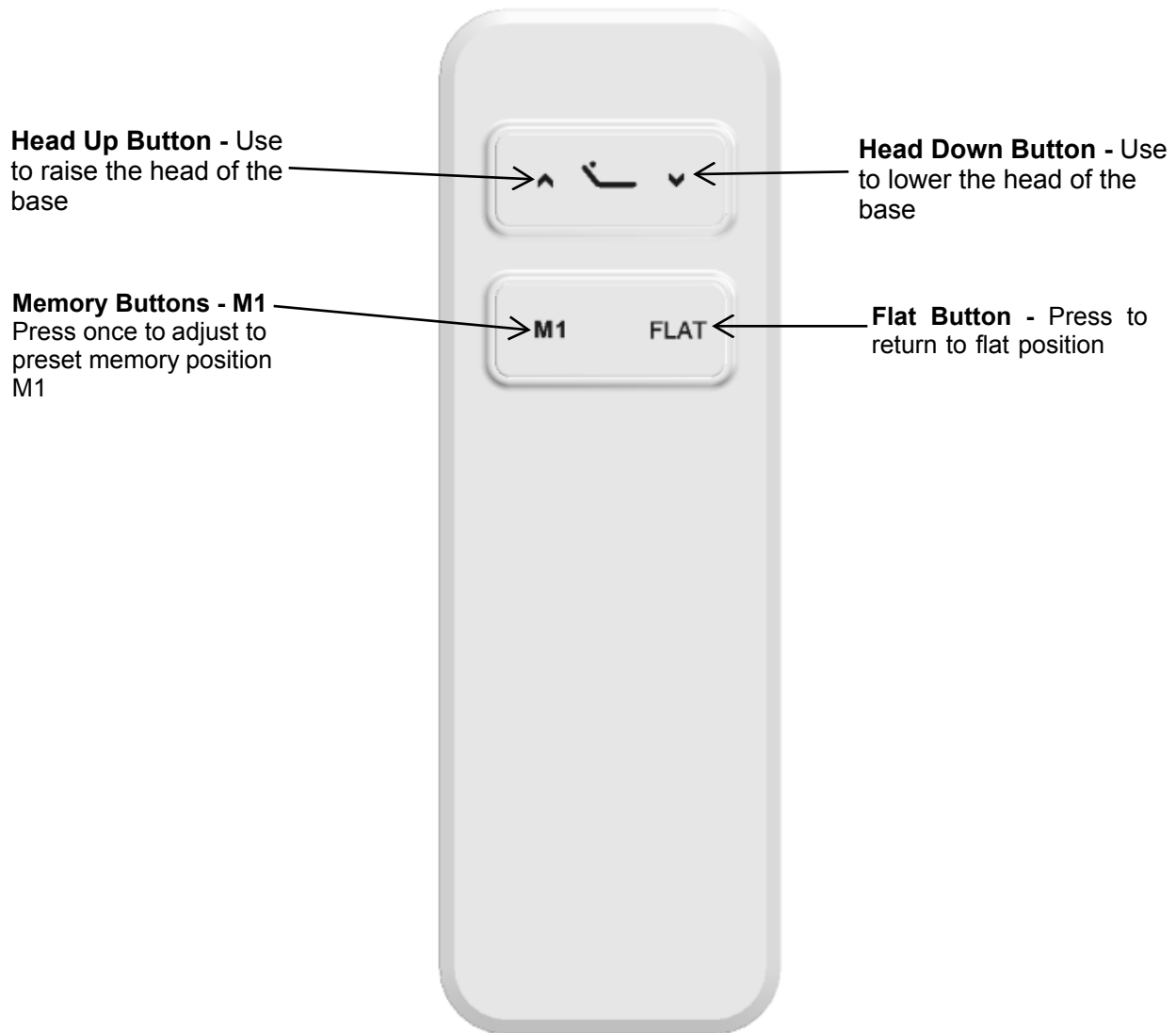

Figure 5

How to Program Memory Position Button:

The remote has one memory button: "M1". The position is not preprogrammed, as each user will have his/her own individual preferences.

1. In order to set memory button, adjust the bed to the desired position.
2. Press and hold the memory button for 3 seconds (Figure 6). A quick beeping sound will confirm that the setting has been successfully saved.
3. The position button (M1) can be reset by repeating steps 1 and 2.



Figure 6

SYNCHRONIZING TWO BEDS

The bed base is designed to allow two twin XL bases to become an Eastern King base and two Split-Cal-King bases to become a Cal-King base. You can use the same Remote to control two side-by-side beds bases by following Step 6 on the installation guide to synchronize one Remote with the two Control Boxes of the two units.

- After base A is paired by following the directions in Step 6, plug in base B and wait for the base to return to flat. You will hear a beep, and it will enter the syncing state for 10 seconds. (If not synced within 10 seconds, please repeat the above step to enter the syncing mode on base B.)
- Using the same remote, simultaneously press the HEAD UP and FLAT button for 3-5 seconds (see figure 7).
- You will hear another beep to signal pairing is complete.

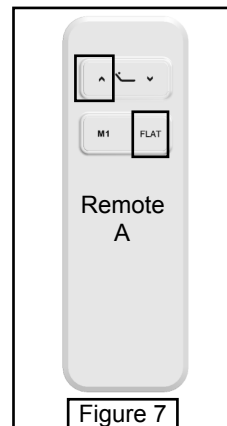

Figure 7

USING BOTH REMOTES ON THE SAME BED

- Sync remote A with both control boxes (control box A first, control box B second) by following the above directions for synchronizing two beds.
- Then sync remote B with the two control boxes (control box B first, control box A second) by following the above directions for Synchronizing Two Beds.
- Now both Wireless Remotes will be able to control both beds.

DESYNCHRONIZING TWO REMOTES

• To remove syncing on one remote, unplug the base and plug it back in. The base will return to flat and you will hear a beep. Press the HEAD UP and FLAT buttons simultaneously for 3-5 seconds. You will hear another beep. To sync again, refer to Step 6 to sync base A with remote A. Then, plug in base B and sync with remote B.

INNOVA SLEEP PRODUCT 1, 3 & 10 YEAR LIMITED WARRANTY

YOUR INNOVA ADJUSTABLE BED BASE (the “Product”) IS COVERED BY THE LIMITED WARRANTY SET FORTH HEREIN.

THIS LIMITED WARRANTY GIVES YOU SPECIFIC LEGAL RIGHTS, AND YOU MAY ALSO HAVE OTHER RIGHTS WHICH VARY FROM STATE TO STATE.

WE WARRANT THAT DURING THE APPLICABLE WARRANTY PERIOD, THE PRODUCT WILL BE FREE FROM DEFECTS IN MATERIALS AND WORKMANSHIP.

INNOVA’S RESPONSIBILITY FOR DEFECTIVE PRODUCTS IS LIMITED TO REPAIR OR REPLACEMENT AS DESCRIBED BELOW.

WHO MAY USE THIS WARRANTY?

Innova Sleep Products, Inc. (“Innova”) extends this limited warranty only to the consumer who is the original purchaser of a new Product (the “Purchaser”). It does not extend to any subsequent owner or other transferee of the Product. Floor model Products and Products sold expressly “as is” are not covered by this limited warranty.

WHAT DOES THIS WARRANTY COVER?

This limited warranty covers defects in materials and workmanship of the Product for the applicable Warranty Period specified below.

WHAT IS NOT COVERED BY THIS WARRANTY?

This limited warranty does not cover any damage due to: (i) transportation, (ii) storage, (iii) improper use, such as use other than personal use in-home exclusively by the Purchaser, (iv) failure to follow the Product operation and maintenance instructions in the Owner’s Manual, this limited warranty, or the Product Precautions, (v) modifications, (vi) unauthorized repair, (vii) normal wear and tear, and/or (viii) external causes such as accidents, abuse, or other actions or events beyond Innova’s reasonable control. This limited warranty also does not cover (a) damage to any products or materials used with, but not constituting or comprising, a Product (including but not limited to mattresses, fabric, cables, electrical cords or items supplied by dealers), (b) the costs of service calls unrelated to any defect (such as in connection with removal, installation, setup, in-home service calls solely for the purpose of educating the Purchaser about the Product or assistance with locating appropriate power connections), and/or (c) reimbursement for inconvenience, loss of use or any other costs or expenses.

WHAT IS THE PERIOD OF COVERAGE?

This limited warranty commences on the Purchaser's date of purchase and lasts for the periods set forth below (the "Warranty Period"), and will not be extended if Innova repairs or replaces any Product or part:

Part Name	Parts Warranty Period	Labor Warranty Period
Motor	3 Year	1 Year
Transformer(s)	3 Year	1 Year
Control Box(es)	3 Year	1 Year
Remote Control	1 Year	
USB Chargers Add-on	1 Year	
Bluetooth Add-on	1 Year	
Frame	10 Year	

WHAT ARE THE PURCHASER'S REMEDIES UNDER THIS WARRANTY?

Year One: Full Labor and Parts Coverage

With respect to any defective Product or part thereof (as listed above) during the first year of the Warranty Period, Innova will, in its sole discretion, either: (i) repair such Product (or the defective part) free of charge to the Purchaser, or (ii) replace the Product (or the defective part) with new or refurbished Product(s) or part(s) free of charge to the Purchaser. Innova will pay all authorized labor and transportation costs associated with any such repair or replacement.

Years Two and Three: Limited Parts Coverage

With respect to any defective Motor, Transformer, Control Box or Frame part(s) during the second and third years of the Warranty Period, Innova will, in its sole discretion, either: (i) repair such Product (or the defective part) free of charge to the Purchaser, or (ii) replace the Product (or the defective part) with new or refurbished Product(s) or part(s); provided, however, that the Purchaser shall be responsible for the cost of all authorized labor and transportation costs associated with any such repair or replacement. This limited warranty shall not apply if the Purchaser does not return any and all defective parts to Innova promptly following Innova's request.

Years Four through Ten: Limited Frame Coverage

With respect to any mechanical part of the Product frame found to be defective during the fourth through tenth years of the Warranty Period, Innova will, in its sole discretion, either: (i) repair such part free of charge to the Purchaser, or (ii) replace the defective part(s) with new or refurbished Product(s) or part(s); provided, however, that the Purchaser shall be responsible for: (a) all transportation costs associated with any such repair or replacement and (b) if the Product is replaced, the Purchaser shall pay to

Innova an amount equal to one-tenth (1/10) of the then-current replacement cost, times the number of years that have elapsed during the Warranty Period as of the time the warranty claim is made. This limited warranty shall not apply if the Purchaser does not return any and all defective parts to Innova promptly following Innova's request.

HOW CAN THE PURCHASER OBTAIN WARRANTY SERVICE?

To obtain warranty service, the Purchaser must call 1-877-386-1373 (US) or 1-833-486-8334 (Canada) or email Innova customer service at service@innovasleep.com during the Warranty Period. No warranty service will be provided, nor may any warranty claim be made, without: (i) the law label tags (see below for information on locating the law labels), and (ii) a sales receipt/proof of purchase showing the date of purchase, the amount paid and the place of purchase.

Innova and/or its service technicians shall not be responsible for moving furniture or any other items not attached to the Product in order to perform service on the Product. It is the sole responsibility of the Purchaser to provide adequate space and accessibility to the Product. In the event that Innova is unable to perform service due to lack of accessibility, the service call will be billed to the Purchaser and the service will have to be rescheduled.

Finding the Law Label

The law label is needed to verify all warranty claims. To locate the law label tags, use remote to bring head of base all the way up so that the base is in the below position:

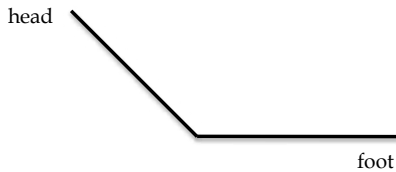

The law label is stapled to the head of the Product base as seen below:



Manufactured By:
 Co: Star Alliance Smart Furniture Co., Ltd
 No.988 Cidong North Avenue, Coastal Economic Development Zone,
 Co: City, Zhejiang Province, China
 Date of Manufacture:
 Importer/ U.S. Records Location:
 Innova Sleep Systems Inc.
 2290 Huntington Drive, Ste 200
 San Marino, CA 91108.
 Model ID: GetGo
 Prototype ID: Multiple
 Foundation ID: GetGo

WARNING

This product can expose you to chemicals including Di(2-ethylhexyl) phthalate (DEHP) which are known to the State of California to cause cancer or birth defects or other reproductive harm. For more information go to www.P65Warnings.ca.gov.

<p>UNDER PENALTY OF LAW THIS TAG NOT TO BE REMOVED EXCEPT BY THE CONSUMER</p> <p>ALL NEW MATERIAL consisting of 100% polyurethane foam .4% EPE .8% plywood made of Poplar .80%</p> <p>REG. NO. CA 45537(CN)</p> <p>Certification is made by the manufacturer that the materials in this article are described in accordance with law</p> <p>MADE FOR INNOVA SLEEP SYSTEMS INC 2290 Huntington Drive, Ste 200 San Marino, CA 91108.</p> <p>Date of Delivery: Finished Size: L 79.5" X W 58.5"</p> <p>Cover: 100% polyester</p> <p>MADE IN CHINA</p>

LIMITATION OF LIABILITY; DISCLAIMERS

THE REMEDIES DESCRIBED ABOVE ARE THE PURCHASER'S SOLE AND EXCLUSIVE REMEDIES AND INNOVA'S ENTIRE LIABILITY UNDER THIS LIMITED WARRANTY. INNOVA'S LIABILITY SHALL UNDER NO CIRCUMSTANCES EXCEED THE ACTUAL AMOUNT PAID BY THE PURCHASER FOR THE DEFECTIVE PRODUCT, NOR SHALL INNOVA UNDER ANY CIRCUMSTANCES BE LIABLE FOR ANY CONSEQUENTIAL, INCIDENTAL, SPECIAL OR PUNITIVE DAMAGES OR LOSSES, WHETHER DIRECT OR INDIRECT.

SOME STATES DO NOT ALLOW THE EXCLUSION OR LIMITATION OF INCIDENTAL OR CONSEQUENTIAL DAMAGES, SO THE ABOVE LIMITATION OR EXCLUSION MAY NOT APPLY TO CERTAIN PURCHASERS.

THE EXTENT PERMITTED BY LAW, THIS WARRANTY AND THE REMEDIES SET FORTH HEREIN ARE EXCLUSIVE AND IN LIEU OF ALL OTHER WARRANTIES, REMEDIES AND CONDITIONS, WHETHER ORAL, WRITTEN, STATUTORY, EXPRESS OR IMPLIED, INCLUDING WITHOUT LIMITATION, WARRANTIES OF MERCHANTABILITY AND FITNESS FOR A PARTICULAR PURPOSE AND WARRANTIES AGAINST HIDDEN OR LATENT DEFECTS. IN SO FAR AS SUCH WARRANTIES CANNOT BE DISCLAIMED, INNOVA LIMITS THE DURATION AND REMEDIES OF ALL IMPLIED WARRANTIES, INCLUDING WITHOUT LIMITATION, THE WARRANTIES OF MERCHANTABILITY AND FITNESS FOR A PARTICULAR PURPOSE TO THE DURATION OF THIS WRITTEN WARRANTY.

SOME STATES DO NOT ALLOW EXCLUSIONS OR LIMITATIONS ON HOW LONG AN IMPLIED WARRANTY MAY LAST, SO THE ABOVE LIMITATION MAY NOT APPLY TO YOU.

TROUBLESHOOTING

If the remote doesn't light up or bed works intermittently:

- a. Change the batteries with **3 AAA lithium batteries of any brand**.
- b. If your base does not work after changing the batteries, check to see if there is a green light on the Transformer, which is the black box on the floor that is attached to the Power Cord that plugs in to the surge protector or wall. Bases should be plugged into a surge protector.

If the remote lights up but does not control the bed base:

If the green light on the Transformer is **ON**

- Check the connections between the Transformer and the Control Box as well as the connections between the Control Box and the actuators.
- Sync bed to the base as described in Step 6 (Page 7).

If the green light on the Transformer is **NOT ON**:

- Check the connection between the Power Cord and Transformer.
- Please unplug your base for 30 minutes and plug it back in and see if the light comes back on.
 - If it does, follow directions for when the green light is on.

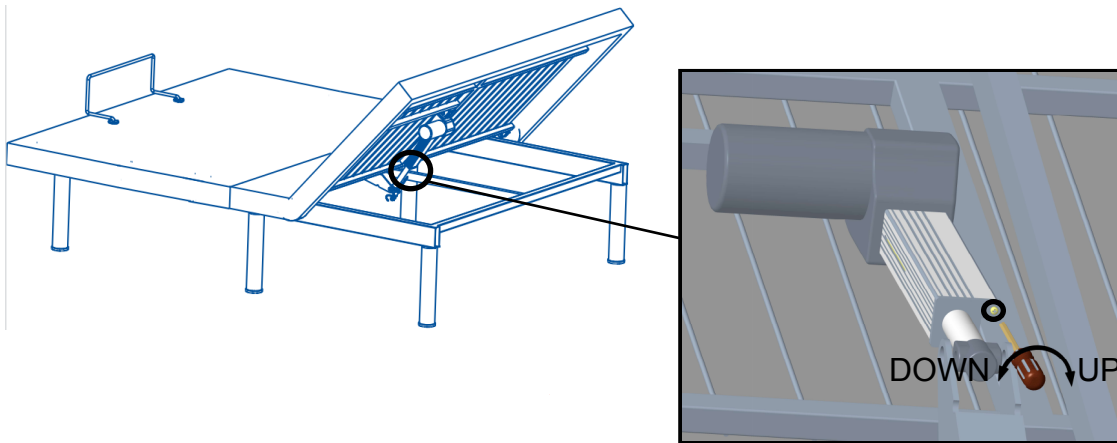
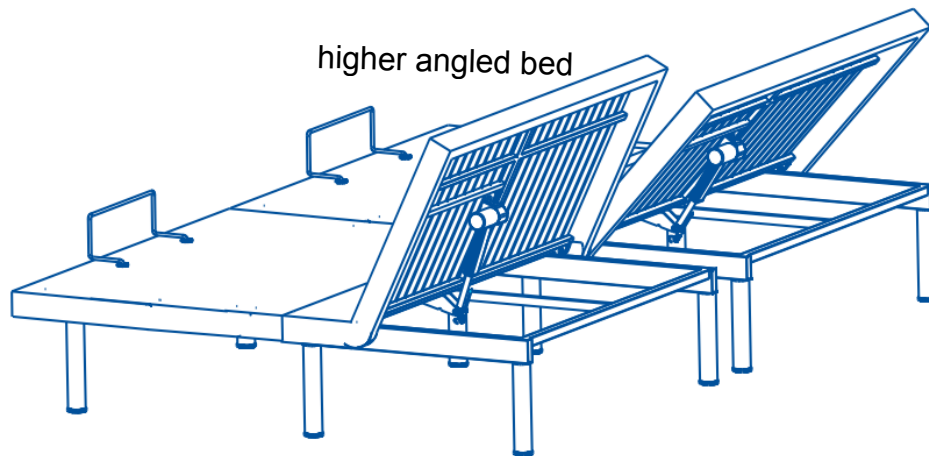

WHEN TWO BEDS DO NOT ALIGN:

On the higher angled bed, use a Phillips head screwdriver to turn the screw of the head actuator counterclockwise 3-5 turns to lower the head angle by 1 degree. Press the head down button on the remote for 5 seconds, then press the head up button to raise the head to the highest angle. If the two beds still do not align, repeat the above steps 2-3 more times until the two higher angled bed matches the level of the lower angled bed when the head of both bases are raised to the highest position. The normal adjustment range is between 58-62. Turning the screw on the head actuator 3-5 times clockwise will raise the head angle by 1 degree; turning the screw on the head actuator 3-5 times counterclockwise will lower the head angle by 1 degree.



**For toll-free customer service, call 1-877-386-1373 (US) or
1-833-486-8334 (Canada) or email
service@innovasleep.com**

Please tell us your name, phone, address, Model Number/ID (found on the law label tags, which are attached to the head of the base), purchase date, and the question or concern when you call or email.

A bed that moves you.

