

Adjustable Base HF01R2Y Wireless

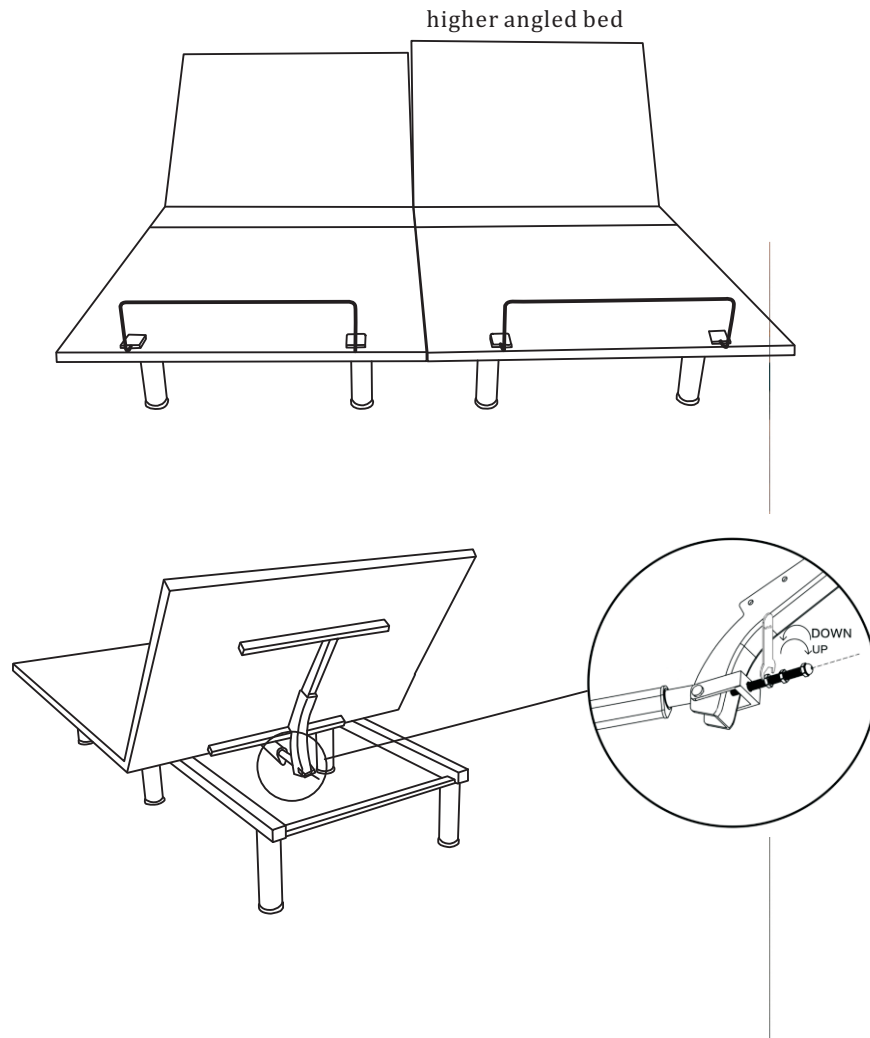

Owner's Manual

INNOVATM
SLEEP SYSTEMS

CONTENTS

Advisory

Setup and Installation

Wireless Hand Control

1-3-10 year Warranty

WHEN TWO BEDS DO NOT ALIGN:
on the higher angled bed of the two, use a 19mm
wrench to turn the nuts on the new "LEVEL RIGHT"
counterclockwise to adjust the angle until the higher
angle bed match the level of the lower angle bed and
lock the nut with the reinforce nuts.

The two beds are now aligned. **(for Twin XL and
Split CK)**

WARNING

Attention: Read the following information before using this product. Failure to use a surge protection device could compromise safety or cause product malfunction and could void the electrical portion of your warranty.

Electrical surges are by far the biggest cause of problems with electrical circuits. In order to help protect your investment in case of a power surge or outage, use an electrical surge protection device (not included).

WARRANTY WARNING!

Do not open or tamper with the transformer, control box, motors, or remote control (with the exception of battery compartments). The product warranty will be void if these components are tampered with.

SMALL CHILDREN AND PETS:

Immediately dispose of all packing materials as they can smother small children and pets. Do not allow any persons or pets under the bed. Children, convalescents and disabled person should not operate the bed without adult supervision.

HOSPITAL OR CONVALESCENT USE DISCLAIMER:

Adjustable beds are designed and engineered for a life style of in-home comfort and are not intended for hospital use or for a bed-ridden patient on an extended recovery. Adjustable beds are not equipped with bars to help patients get safely in and out of bed and are not intended to be used around tent type oxygen therapy or explosive gases.

motors and massage motors are also excluded. This limited lifetime warranty shall not apply unless the defective part is returned to Innova and Innova receive all service and transportation cost for verification. In years 3-10 years, purchaser shall pay all service and transportation costs related to the replacement of the defective part and required to pay 1/10 of the current replacement cost of the parts times the number of years used.

ADDITIONAL TERMS AND CONDITIONS

This warranty does not apply: (a) to any damage caused by the purchaser; (b) if there has been any repair or replacement of adjustable bed parts by an unauthorized person; (c) if the adjustable bed has been mishandled (whether in transit or by other means), viz, subjected to physical or electrical abuse or misuse, or otherwise operated in any manner inconsistent with the operation and maintenance procedures outlined in the Owner's Manual and this warranty; (d) to damage to mattresses, fabric, cables, electrical cords or items supplied by dealers. (Contact the dealers for warranty information on those items;) (e) if there has been any modification of the adjustable bed without prior written consent by Innova; (f) to costs for unnecessary service calls, including costs for in-home service calls solely for the purpose of education the consumer about the adjustable bed or finding an unsatisfactory power connection; (g) if the recommended weight restriction is not followed (refer to the advisory section of this manual), the warranty will be void; (h) to the use of the adjustable bed base in whatsoever and howsoever manner other than the personal in home use exclusively by the purchaser.

Repairs to or replacement of an adjustable bed base or its components under the terms of this limited warranty will apply to the original warranty period and will not serve to extend such period. The decision to repair or to replace defective parts under this warranty shall be made, or cause to be made, by Innova at its option and in its sole discretion. Repair or replacement shall be the sole remedy available to the purchaser. There shall be no liability on the part of Innova for any special, indirect, incidental, or consequential damages or to any other damage, claim, or loss not expressly covered by the terms of this warranty. This limited warranty does not include reimbursement for inconvenience, removal, installation, setup time, loss of use, shipping, or any other costs of expenses, Innova and/or its service technicians shall not be responsible for moving furniture or any other items not originally attached to the adjustable bed in order to perform service on the adjustable bed. It is the sole responsibility of the purchaser to provide adequate space and accessibility to the adjustable bed. In the event that the technician is unable to perform service due to lack of accessibility, the service call will be billed to the purchaser and the service will have to be rescheduled. Innova makes no other warranty whether expressed or implied, and all implied warranties of merchantability and fitness for a particular purpose are disclaimed by Innova and excluded from this warranty. Some states do not allow the exclusion or limitation of incidental or consequential damages, so the above limitation or exclusion may not apply to every purchaser. This warranty gives the purchaser specific legal rights, and the purchaser may also have other rights, which may vary from state to state. This warranty is valid in all 50 states, Puerto Rico, and Canada.

WARNING

Attention: Read the following information before using this product. Failure to use a surge protection device could compromise safety or cause product malfunction and could void the electrical portion of your warranty.

Electrical surges are by far the biggest cause of problems with electrical circuits. In order to help protect your investment in case of a power surge or outage, use an electrical surge protection device (not included).

WARRANTY WARNING!

Do not open or tamper with the transformer, control box, motors, or remote control (with the exception of battery compartments). The product warranty will be void if these components are tampered with.

SMALL CHILDREN AND PETS:

Immediately dispose of all packing materials as they can smother small children and pets. Do not allow any persons or pets under the bed. Children, convalescents and disabled person should not operate the bed without adult supervision.

HOSPITAL OR CONVALESCENT USE DISCLAIMER:

Adjustable beds are designed and engineered for a life style of in-home comfort and are not intended for hospital use or for a bed-ridden patient on an extended recovery. Adjustable beds are not equipped with bars to help patients get safely in and out of bed and are not intended to be used around tent type oxygen therapy or explosive gases.

motors and massage motors are also excluded. This limited lifetime warranty shall not apply unless the defective part is returned to Innova and Innova receive all service and transportation cost for verification. In years 3-10 years, purchaser shall pay all service and transportation costs related to the replacement of the defective part and required to pay 1/10 of the current replacement cost of the parts times the number of years used.

ADDITIONAL TERMS AND CONDITIONS

This warranty does not apply: (a) to any damage caused by the purchaser; (b) if there has been any repair or replacement of adjustable bed parts by an unauthorized person; (c) if the adjustable bed has been mishandled (whether in transit or by other means), viz, subjected to physical or electrical abuse or misuse, or otherwise operated in any manner inconsistent with the operation and maintenance procedures outlined in the Owner's Manual and this warranty; (d) to damage to mattresses, fabric, cables, electrical cords or items supplied by dealers. (Contact the dealers for warranty information on those items;) (e) if there has been any modification of the adjustable bed without prior written consent by Innova; (f) to costs for unnecessary service calls, including costs for in-home service calls solely for the purpose of education the consumer about the adjustable bed or finding an unsatisfactory power connection; (g) if the recommended weight restriction is not followed (refer to the advisory section of this manual), the warranty will be void; (h) to the use of the adjustable bed base in whatsoever and howsoever manner other than the personal in home use exclusively by the purchaser.

Repairs to or replacement of an adjustable bed base or its components under the terms of this limited warranty will apply to the original warranty period and will not serve to extend such period. The decision to repair or to replace defective parts under this warranty shall be made, or cause to be made, by Innova at its option and in its sole discretion. Repair or replacement shall be the sole remedy available to the purchaser. There shall be no liability on the part of Innova for any special, indirect, incidental, or consequential damages or to any other damage, claim, or loss not expressly covered by the terms of this warranty. This limited warranty does not include reimbursement for inconvenience, removal, installation, setup time, loss of use, shipping, or any other costs of expenses, Innova and/or its service technicians shall not be responsible for moving furniture or any other items not originally attached to the adjustable bed in order to perform service on the adjustable bed. It is the sole responsibility of the purchaser to provide adequate space and accessibility to the adjustable bed. In the event that the technician is unable to perform service due to lack of accessibility, the service call will be billed to the purchaser and the service will have to be rescheduled. Innova makes no other warranty whether expressed or implied, and all implied warranties of merchantability and fitness for a particular purpose are disclaimed by Innova and excluded from this warranty. Some states do not allow the exclusion or limitation of incidental or consequential damages, so the above limitation or exclusion may not apply to every purchaser. This warranty gives the purchaser specific legal rights, and the purchaser may also have other rights, which may vary from state to state. This warranty is valid in all 50 states, Puerto Rico, and Canada.

INNOVA SLEEP PRODUCT

1, 3 & 10 YEAR LIMITED WARRANTY

Innova Sleep Products, Inc. (“Innova”) warrants this adjustable bed to the consumer who is the original purchaser of a new product which was not sold “as is” (the “purchaser”), subject to the terms and conditions set forth herein. This warranty begins on the “warranty commencement date” which is the date of purchase for new unused beds base.

Part Name	Parts warranty period	Labor warranty period
Motor(s)	3 years	1 year
Transformer(s)	3 years	1 year
Remote control	3 years	1 year
Control box(es)	3 years	1 year

During the Parts warranty period, there will be no charge for parts.
During the Labor warranty period, there will be no charge for labor.

If repair is needed during the warranty period, the purchaser will be required to produce a sales receipt/proof of purchase evidencing the date of purchase, the amount paid and the place of purchase. If no such sales receipt/proof of purchase is produced, full amount of charges for labor and the parts shall be paid before any services could be rendered.

FULL 1 YEAR WARRANTY

This adjustable bed is warranted against defects in the workmanship or materials for a period of one (1) year from the warranty commencement date. Upon notice during the first year after the warranty commencement date, Innova will repair or replace (at no cost to the purchaser) any defective adjustable bed base part with new or refurbished parts, and Innova will pay all authorized labor and transportation costs associated with the repair or replacement of any parts found to be defective. When the adjustable bed at hand is found to be DAMAGE, not DEFECT, all costs incurred to inspect and /or correct the requested issue will be the financial responsibility of the requesting party.

3 YEAR LIMITED WARRANTY

During the second year from the warranty commencement date, upon receipt of notice, Innova will replace any adjustable bed base part found to be defective with new or refurbished parts. Purchaser shall pay all service and transportation costs related to the replacement of the defective part. This limited two (3) year warranty shall not apply unless the defective part is returned to Innova and Innova receive all service and transportation cost for verification.

10 YEAR LIMITED WARRANTY

Upon written notice during the third year through the 10th year from the warranty commencement date, Innova will replace, upon terms and conditions set forth in this paragraph, any mechanical bed base parts found to be defective. Electronics, electrical components, drive

PRODUCT RATINGS:

The bed lift motors are not designed for continuous use of more than 2 minutes in an 18 minutes period, or approximately 10% duty cycle. **Any attempt to circumvent or exceed this rating will shorten the life expectancy of the product and may void the warranty.**

WEIGHT UNITS:

The limitation for this adjustable bed is 750 lbs. The bed will structurally support these weights, provided it is evenly distributed across the head and foot sections. This product is not designed to support or lift this amount in the head or foot section alone. **Exceeding this weight restriction could damage the bed and/or cause injury and void the warranty.** Enter or exit the bed in a flat position and do not sit on the head or foot sections while in the raised position.

LIFTING AND LOWERING MECHANISMS :

It is normal for the raising and lowering feature on this bed to emit a minimal humming sound during operation.

LOCATION ENVIRONMENT:

The level of sound experienced in a room is directly related to the environment within that location. In a room with hardwood floors and the massagers turned on, a vibrating noise can be noticeable. To reduce the resonance, place a piece of carpet or rubber casters cups under the legs. The rubber caster cups also prevent the bed sliding when located on smooth or hard surface flooring.

TO REDUCE THE RISK OF SHOCK, BURNS, FIRE OR INJURY:

Make sure the base is in a flat position. Always unplug the base from the electrical outlet before cleaning or servicing the base. If the cord or plug is damaged, discontinue use of the bed base and contact qualified service personnel for examination and repair.

FCC COMPLIANCE:

This device complies with part 15 of the FCC Rules for residential use. Operation is subject to the following two conditions: (1) This device may not cause harmful interference, and (2) this device must accept any interference received, including interference that may cause undesired operation.

Radio Frequency: 2.4 GHz

EMERGENCY BATTERY BACKUP:

In the event that the base is stuck in an articulated position during a power outage-the battery backup in the transformer will return the base to flat position. Batteries are not to be used for normal operation of the base. Install two 9 volt alkaline batteries into the battery backing transformer. Use the reset button on the control box or the extension cord from the control box to the transformer to return the base to a flat position.

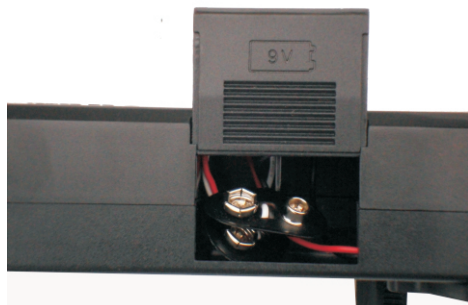

INNOVA SLEEP SYSTEMS Wireless Remote Adjustable Beds

Preset P1 and P2 Buttons

1. Adjust the head and foot to desired position .
2. Press and continue holding in the "P1" or "P2" Button for around 7 seconds , the beeping sounds confirm the successful setting.
3. You can reset the 2 position buttons by repeating the above steps .

Synchronize the remote with the control box.

Press these Head down and Foot up buttons at the same time , then press the small button on the side of the Control Box , the beeping sounds confirm the remote sync with the control box.

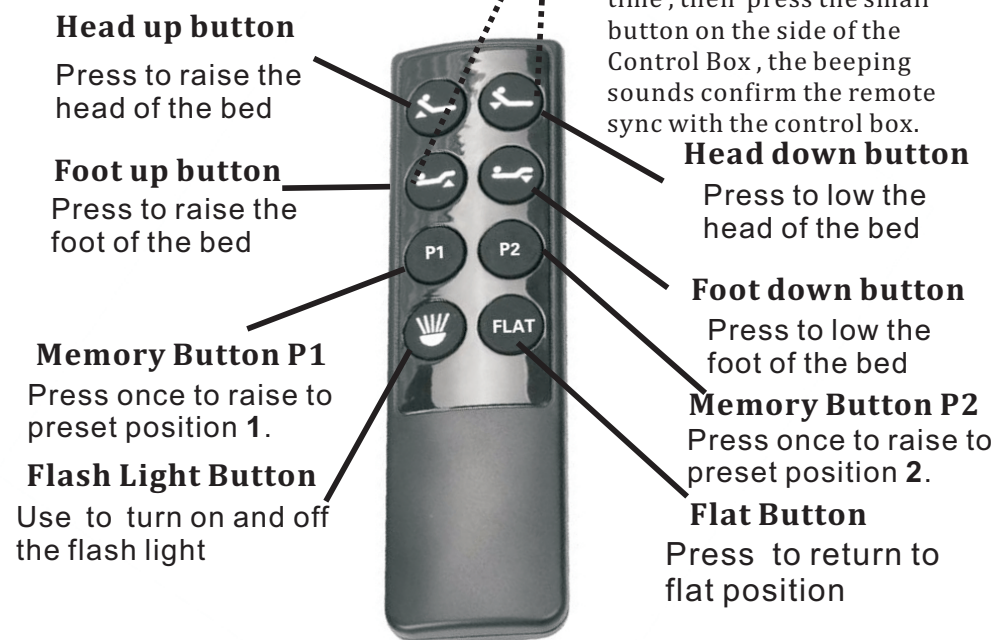

For toll-free customer service, call 1-877-386-1373
email us: service@innovasleep.com
Please tell us your name, phone, address , serial No.
(found on the foot beam of the bed),
and the problem when you call/email.

USING SAME REMOTE

The bed base is designed to allow two twin X-Long bases to become an Eastern King base and two Split-Cal-King bases to become a Cal-King base. And you can use the same remote to control two side by side beds bases by following Step 7 on the installation guide to synchronize the remote with the two control boxes of the two units.

USING 2 REMOTE ON SAME BED

Press the HEAD UP and FOOT UP button of a new remote B (the one that have not sync with the beds), until the flash light flashing, then release the two buttons, The flash light will be on for 10 seconds. **Meanwhile** press the HEAD DOWN and FOOT UP button of the Master Remote A, the copying process is successful when the clone flash light start to flash. Now both remote control will be able to control both beds to same position. (see figure 7)

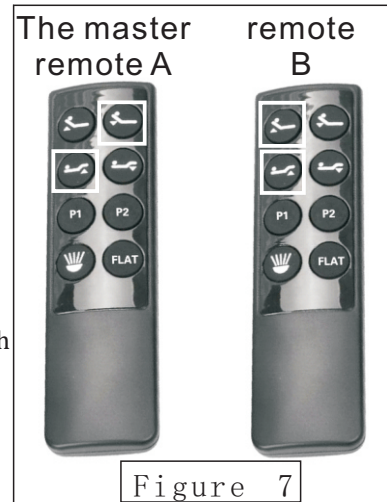

To desynchronize the clone remote B from master remote A, press the HEAD UP and FOOT DOWN button of the clone remote B, the desynchronizing process is successful when the clone remote B flash light normally on. (see figure 8)

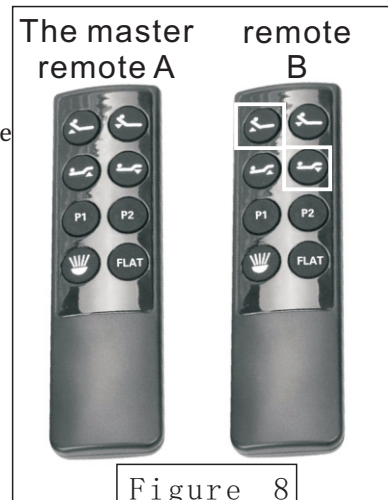

Setup is now complete. Enjoy.

SETUP and INSTALLATION

Important: We strongly recommend Two able-bodied adults setup and assemble this product.

Step 1:

Check and verify all parts are included before discarding any packing materials.

All electronics and components that need to be installed are located in boxes under the base or attached to the frame.

- A) Wireless Remote Control (1)
- B) Mattress Retainer Bar (1)
- C) Legs -3"+3"+6" (6)
- D) Power Cord (1)
- E) Transformer (1)
- F) Control Box (1)
- G) Registration Form (1)

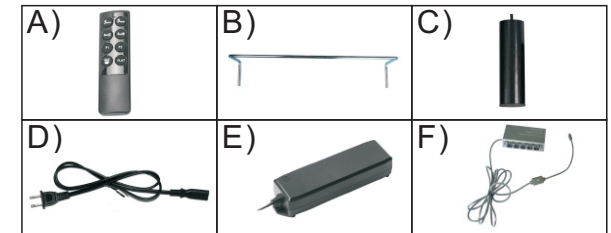

Step 2:

With the help of your able-bodied assistant, place carton on floor with arrows point downwards.

Step 3:

Connect the Transformer "E" to Control Box "F": The Control Box is the Black Box attached to the bottom of the bed. Extend the Power Cord from the Control Box "F" and attach to the short electrical output cord on Transformer "E". Extend the Power Cord "D" and plug it into the Transformer "E". (See Figure 1)

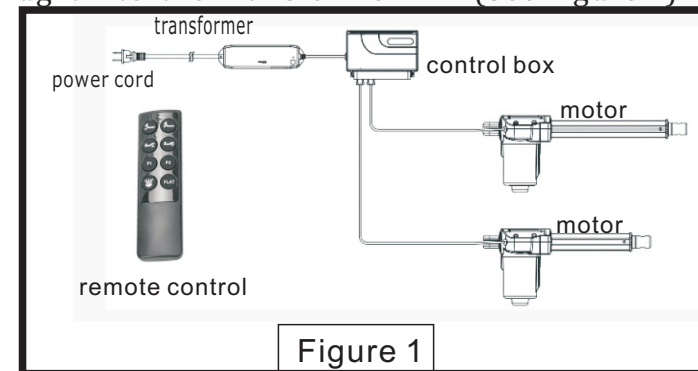

Step 4:
 Locate the Wireless Remote control and insert 2 AAA batteries
 (See Figure 3)

Step 5 & 6:
 Plug electrical cord into a grounded electrical outlet. Using the Wireless Remote, push the Head Up button, Foot Up button for a momentary test of the Wireless Remote. If the motor is working quickly let go of the button and skip to step 8.

Step 7:
 Synchronize the remote control with the control box. First find the control box mounted in the mid section of the bed. Press HEAD DOWN and FOOT UP buttons simultaneously, then press the RESET button (See Fig.4) on the side of the control box or on the extension cord, you will hear some quick beeping sounds. The adjustable bed should be working after matching the remote control with the control box. Press the HEAD UP button to test. The RESET button also can be used as emergency lowering to flat the bed base, when press once, it adjusts bed to the level position.

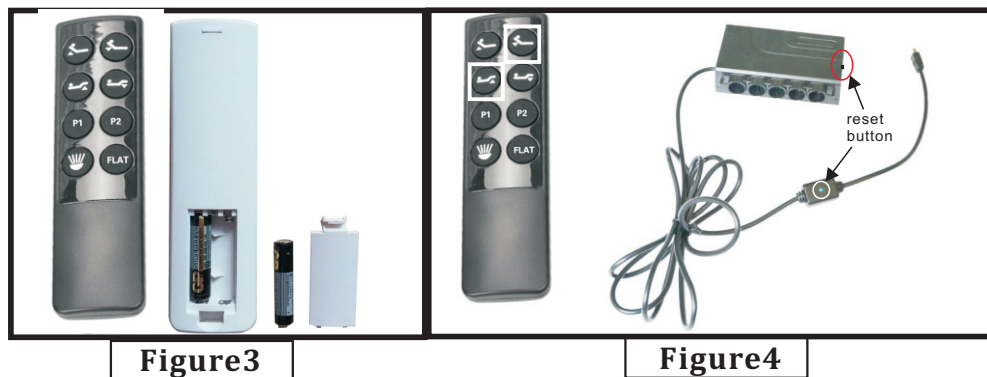

Step 8:
 -Unplug the Power Cord.
 -Install the four legs firmly into the base of the frame. The legs screw into the threaded holes in each corner of the adjustable base frame (See Figure 2).
 -Do not over tighten.

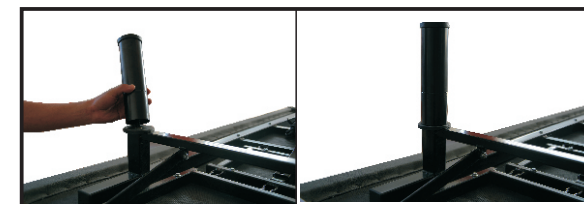

Figure 2

Step 9:
 With the help of your able-bodied assistant, carefully lift the adjustable bed frame and set it in place upright on its legs. Excessive pressure may damage the legs. Remove all protective plastic covering. Note: check and make sure that all power cords clear and do not interfere with any Adjustable Bed Mechanisms; Dispose of covering property to avoid injury.

Step 10:
 Note: The Mattress Retaining Bar is mounted upside down for shipping only. Remove the Mattress Retaining Bar on the foot of the bed and turn the bar upright and reinstall by carefully aligning and pushing the bar into place. Inset the retaining clips to secure the bar into place. (See Figures 5 & 6.) The retaining bar is to prevent the mattress from slipping out the base and should not be used as a handle of the base. Using as a handle will damaged the retaining bar holders. Screws come out from the retainer bar holders will be considered as a damaged part and not a defective part and is not covered by the warranty.



Figure 5

Figure 6